

Virus

© design by Dirk Wynants

extremis®



Dimensions

The Virus 3-seater is available in one dimension and 2 versions

1. Standard tabletop with drainage holes and parasol hole
2. Solid tabletop, no parasol hole

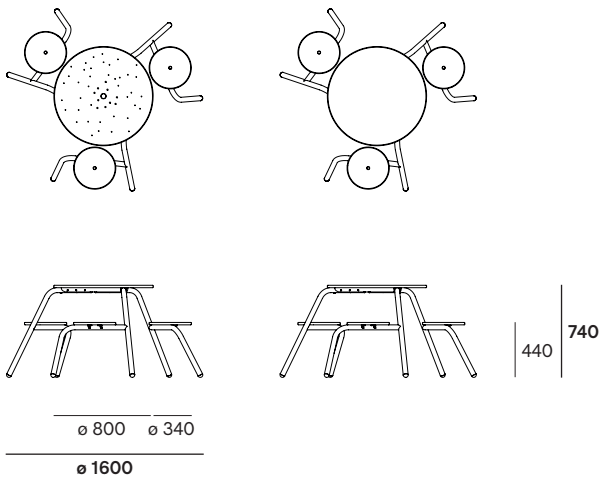

The Virus 4-seater is available in one dimension and 2 versions

1. Standard tabletop with drainage holes and parasol hole
2. Solid tabletop, no parasol hole

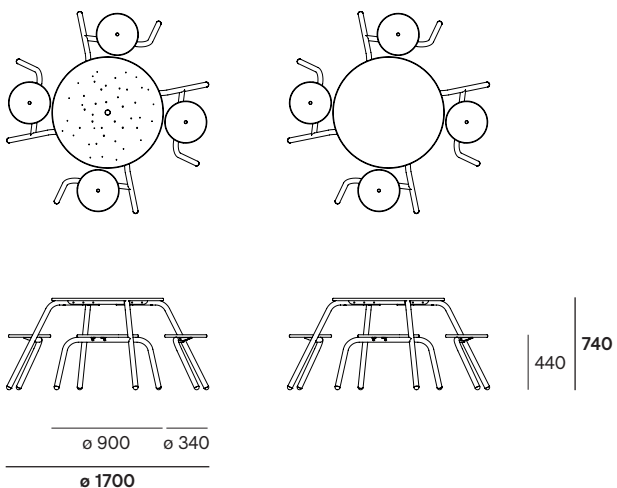

The Virus 5-seater is available in one dimension and 2 versions

1. Standard tabletop with drainage holes and parasol hole
2. Solid tabletop, no parasol hole

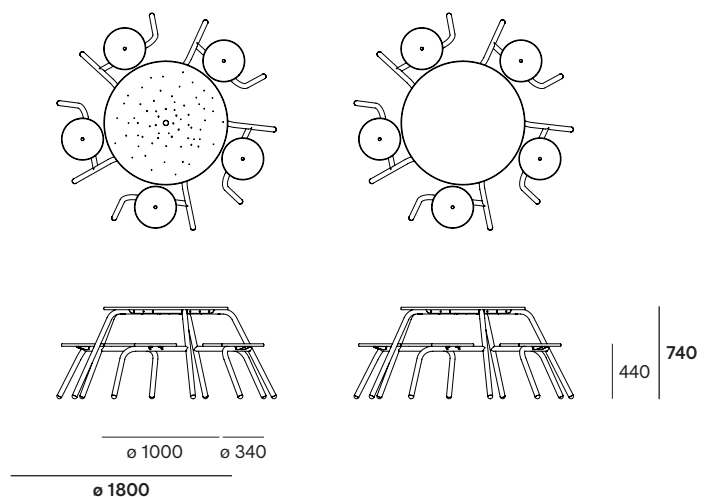

Box dimensions

The Virus comes in 2 boxes

Box 1: Tabletop + mounting kit



Box 2: Legs + seats

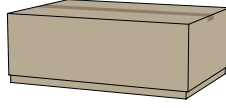

Max volume: **up to 10 legs with seats per box 2**

0,53 m³ | Gross weight: 63,80 kg | Net weight: 58,18 kg

Box dimensions (mm)		L	W	H	Qty	Volume (m3)	Gross weight (kg)	Net weight (kg)	Packaging weight (kg)
Virus 3-seater	Box 1	800	800	70	1	0,05	16,60	14,80	1,80
	Box 2	1140	790	375	1	0,34	22,99	17,37	5,62
					Total	0,39	39,59	32,17	7,42
Virus 4-seater	Box 1	900	900	70	1	0,06	19,60	17,80	1,80
	Box 2	1140	790	375	1	0,34	28,82	23,18	5,62
					Total	0,40	48,42	40,98	7,42
Virus 5-seater	Box 1	1000	1000	70	1	0,07	23,60	21,60	2,00
	Box 2	1140	790	450	1	0,41	34,65	29,03	5,62
					Total	0,48	58,25	50,63	7,62

Backrest dimensions

The backrest is available in one dimension

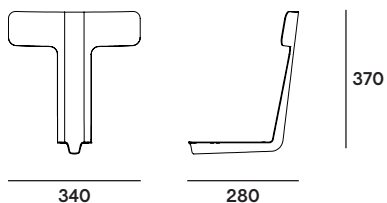

Box dimensions

The backrest comes in one box

Box 3: backrests

Max volume: **up to 10 backrests per box 3:**

0,07 m³ | Gross weight: 19,90 kg | Net weight: 19,10 kg

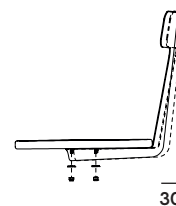
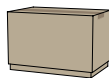

assembly position 2: lean back - allows more body depth

assembly position 1: standard

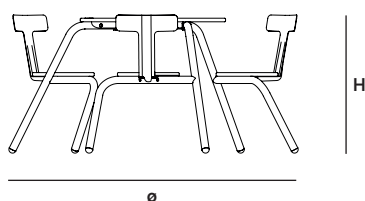

Dimensions (mm)	L _{position 1}	L _{position 2}	H	ø _{position 1}	ø _{position 2}
Backrests on 3-seater	/	/	760	1644	1674
Backrests on 4-seater	/	/	760	1744	1774
Backrests on 5-seater	/	/	760	1844	1874

Box dimensions (mm)		L	W	H	Qty	Volume (m ³)	Gross weight (kg)	Net weight (kg)	Packaging weight (kg)
Backrest	Box 3	540	340	320	1	0,06	2,71	1,91	0,80

Cushions dimensions

The cushion is available in 1 dimension

The optional cushions are delivered inside the box with the legs & seats: 0,31 kg/pc

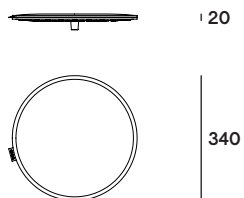

Floor fastening dimensions

The floor fastening is available in 1 dimension



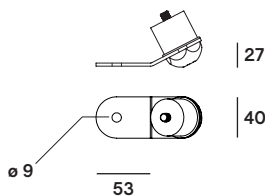



The optional floor fastening is delivered inside the box with the legs & seats: 0,13 kg/pc









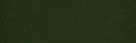

Materials & colors

Check price list or www.extremis.com for current materials & colors

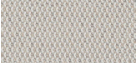
Tabletop, frame, seats, legs & backrests

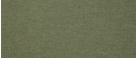
	Papyrus white (RAL9018) Structured powder coating
	Verdigris Structured powder coating
	Reed green (RAL6013) Structured powder coating
	Copper brown (RAL8004) Structured powder coating
	Black red (RAL3007) Structured powder coating
	Cobalt blue (RAL5013) Structured powder coating
	Beige red (RAL3012) Structured powder coating
	Bottle green (RAL6007) Structured powder coating

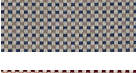
Sunbrella® cushions

	Grey chiné Sunbrella Natté
	Dark taupe Sunbrella Natté
	Marble Sunbrella Lopi
	Charcoal Sunbrella Lopi
	Leaf green Sunbrella Heritage
	Indigo Sunbrella Heritage
	Loto Sunbrella Domino
	Craps Sunbrella Domino



Materials	Key facts	Thickness	Layer thickness	Density	In/outdoor	Water	UV color fastness	Flame retarding
		mm	micron					
Structured powder coated ZnAlMg steel tabletop & seat	<ul style="list-style-type: none"> A technique of applying dry paint to a part Electrostatically charged and sprayed onto the object More scratch-resistant than non structured powder coated 	1,50	60	7,50 10 ³ kg/m ³	Outdoor & indoor	n.a.	Very good: color can fade to some extent when exposed to UV	NEN-EN 13501-1 A2-s1 **
Structured powder coated electro galvanized steel tabletop frame	<ul style="list-style-type: none"> Easy to clean Electro galvanized (for an extra protection against rust), then powder coated More scratch-resistant than non structured powder coated 	4	100	7,50 10 ³ kg/m ³	Outdoor & indoor	n.a.	Very good: color can fade to some extent when exposed to UV	NEN-EN13501-1 A1 *
Structured powder coated steel tabletop frame (only for 2-seater)	<ul style="list-style-type: none"> Easy to clean More scratch-resistant than non structured powder coated 	2	80	8,00 10 ³ kg/m ³	Outdoor & indoor	n.a.	Very good: color can fade to some extent when exposed to UV	NEN-EN13501-1 A1 *
Structured powder coated stainless steel legs	<ul style="list-style-type: none"> Easy to clean Stainless steel (for protection against rust), then powder coated More scratch-resistant than non structured powder coated 	2	80	8,00 10 ³ kg/m ³	Outdoor & indoor	n.a.	Very good: color can fade to some extent when exposed to UV	NEN-EN13501-1 A1 *
Sunbrella® cushions	<ul style="list-style-type: none"> 100% Sunbrella Acrylic Best outdoor fabric available for making cushions Dirt repellent Not waterproof, store inside! Machine washable at max. 30°C. Ironing restores the protective layer 	0,50	n.a.	260 g/m ²	Outdoor & indoor	The fabric has a water column of 350 mm (EN 20811)	7/8 (ISO 105-B02)	/
Stainless steel AISI 316 floor fastening	<ul style="list-style-type: none"> High rust resistance Periodical maintenance required 	1,50	n.a.	8,00 10 ³ kg/m ³	Outdoor & indoor version	n.a.	Very good	NEN-EN13501-1 A1 *

NEN-EN13501-1 A1

Class A1 products will not contribute to fire in any stage, including fully developed fire. For this reason, they are assumed to be capable of satisfying all requirements of all lower classes as well.

NEN-EN13501-1 A2-sl

Satisfying the same criteria as class B for the SBI-test according to EN 13823. In addition, under conditions of a fully developed fire these products will not significantly contribute to the fire load and fire growth

Good to know

- Acquiring a Virus table is space saving. Virus requires only the exact space that is needed for a company of 3, 4 or 5 people. The identical seating frame is configured around a tabletop that fits exactly what you need for a simple lunch or breakfast. Nothing more, nothing less.
- There is a version with a flat tabletop and a version with drainage holes & a parasol hole of ø38 mm.
- Virus combines perfectly with Acacia or Inumbrina small / medium (only with parasol foot).



- Stacking spacer (& purse hanger) included.
- Our Virus picnic tables are stackable up to 3 high. Stack them with equal number of seats. A 3-seater needs three pieces, a 4-seater needs four pieces, and so on.



Maintenance

POWDER COATED PARTS

- White powder coating obviously requires more maintenance.

SUNBRELLA

- Shake or brush off loose dirt immediately.
- Spray Extremis Multi Cleaner.
- Use a soft brush and make circular movements.
- Let the suds soak in for a moment.
- Rinse thoroughly to remove all soap residue.
- Simply allow to dry.
- It's also possible to put the blanket and the pillow covers in a washing machine (max 40°C). Follow the cleaning instruction on the label

F.A.Q.

Q: Is it possible to stack the table?

A: It is possible. You can stack Virus up to 3 pieces with equal number of seats. To avoid damage, use blankets.

Q: Why are the seats hollow?

A: For comfort reason and water drainage.

Fun fact

The holes in the tabletop are a pattern of stars in the galaxy M101 (Pinwheel Galaxy).

Warnings

General

- Do not use any sharp tools to open the packaging.
- We strongly advise against using power tools.
- Tripping hazard, mind your step.
- Do not put out cigarettes on the table.
- Not graffiti proof.
- Do not leave children unattended whilst playing on the table.
- To avoid danger of suffocation, keep plastic bags away from babies and children.
- Colors can differ over years and from batch to batch.

Product

- Do not stand or jump on the table.
- Do not drag the table, but carry it with minimum 2

people.

- Anchoring the product has to be done by qualified people.
- For anchoring: use suitable bolts or screws from a specialized store depending on the material your terrace is made of.
- Stackable up to 3 pieces and protect with blankets.
- Always stack the tables with 2 people.
- Do not sit on the tabletop.
- Max. 1 person or 120 kg per seat.

Powder coating

- White powder coating requires more maintenance.
- Do not use abrasive scouring powders or scourers as they will scratch the surface.
- Color can fade to some extent when exposed to UV.

- Flame retarding - NEN-EN13501-1 A2-sl - Satisfying the same criteria as Class B for the SBI-test according to EN13823. In addition, under conditions of a fully developed fire these products will not significantly contribute to the fire load and fire growth.
- Dark colors can get very hot in sunny weather.

Sunbrella

- Not waterproof, store inside!
- Shake or brush off loose dirt immediately.
- UV color fastness: 7/8 (ISO 105-B02).